



IT POMPE A MEMBRANE PER USO AGRICOLO
ISTRUZIONI PER L'ASSEMBLAGGIO E LA
MANUTENZIONE - **SERIE APS**

EN DIAPHRAGM PUMPS FOR AGRICULTURAL USE
ASSEMBLY AND MAINTENANCE INSTRUCTIONS
- **APS SERIES**

FR POMPES À MEMBRANES POUR USAGE AGRICOLE
INSTRUCTIONS POUR L'ASSEMBLAGE ET
L'ENTRETIEN - **SÉRIE APS**

ES BOMBAS DE MEMBRANAS PARA USO AGRÍCOLA
INSTRUCCIONES PAR A EL ENSAMBLAJE Y EL
MANTENIMIENTO - **SERIE APS**

CS MEMBRÁNOVÁ ČERPADLA PRO ZEMĚDĚLSKÉ
POUŽITÍ, NÁVOD K MONTÁŽI A ÚDRŽBĚ
- **SÉRIE APS**

DE MEMBRANPUMPEN FÜR LANDWIRTSCHAFTLICHEN
GEBRAUCH, ANWEISUNGEN FÜR DEN ZUSAM-
MENBAU UND DIE WARTUNG - **SERIE APS**

EL ΑΝΤΙΛΙΕΣ ΜΕΜΒΡΑΝΗΣ ΓΙΑ ΑΓΡΟΤΙΚΗ ΧΡΗΣΗ
ΟΔΗΓΙΕΣ ΓΙΑ ΤΗΝ ΣΥΝΑΡΜΟΛΟΓΗΣΗ ΚΑΙ
ΣΥΝΤΗΡΗΣΗ - **ΣΕΙΡΑ APS**

HU MEZŐGAZDASÁGI CÉLÚ MEMBRÁNSZIVATTYÚK
- ÖSSZEÁLLÍTÁSI ÉS KARBANTARTÁSI ÚTMUTATÓ
- **APS SZÉRIA**

NL MEMBRAANPOMPEN VOOR LANDBOUWGEBRUIK
MONTAGE- EN ONDERHOUDSAANWIJZINGEN
- **SERIE APS**

PL POMPY PRZEPONOWE DO ZASTOSOWANIA W ROL-
NICTWIE, INSTRUKCJE MONTAŻOWE I KONSERWACJI
- **SERIA APS**

PT BOMBAS DE MEMBRANAS PARA USO AGRÍCOLA
INSTRUÇÕES DE MONTAGEM E MANUTENÇÃO
- **SÉRIE APS**

SK MEMBRÁNOVÉ ČERPADLÁ NA POĽNOHOSPODÁRSKE
POUŽITIE, POKYNY NA MONTÁŽ A ÚDRŽBU
- **SÉRIA APS**

SL ZASLONILNE ČRPALKE ZA UPORABO V KMETIJSTVU -
NAVODILA ZA MONTAŽO IN VZDRŽEVANJE
- **APS SERIJE**

FI KALVOPUMPPU MAATALOUSKÄYTTÖÄ VARTEN
KOKOAMIS- JA HUOLTO-OHJEET
- **APS SARJA**

SV DIAFRAGMAPUMPAR FÖR ANVÄNDNING INOM
JORDBRUK - MONTERINGS- OCH
UNDERHÅLLSANVISNINGAR - **APS-SERIE**

RU МЕМБРАННЫЕ НАСОСЫ ДЛЯ СЕЛЬСКОХОЗЯЙСТВЕННОГО
ПРИМЕНЕНИЯ, ИНСТРУКЦИИ ПО МОНТАЖУ И
ТЕХОБСЛУЖИВАНИЮ - **СЕРИЯ APS**

RO POMPE CU DIAFRAGMĂ PENTRU UTILIZARE ÎN
AGRICULTURĂ - INSTRUCȚIUNI DE ASAMBLARE ȘI
ÎNȚREȚINERE - **SERIA APS**

APS SERIES



IT • ATTENZIONE. Leggere le istruzioni prima dell'uso e dell'assemblaggio

EN • WARNING. Read the instructions before use and assembly

FR • ATTENTION. Lire les instructions avant l'utilisation et l'assemblage

ES • ATENCIÓN. Leer las instrucciones antes del uso y del ensamblaje

CS • UPOZORNĚNÍ. Před použitím a montáží zařízení si pečlivě přečtěte poskytnuté pokyny

DE • ACHTUNG. Vor der Verwendung und dem Zusammenbau die Anweisungen lesen

EL • ΠΡΟΣΟΧΗ. Διαβάστε τις οδηγίες πριν από τη χρήση και την συναρμολόγηση

HU • FIGYELEM. A berendezés összeállítása és használatá előtt kérjük, olvassa el az utasításokat

NL • OPGELET. De aanwijzingen voor het gebruik en de montage doorlezen

PL • UWAGA. Przed użyciem i zmontowaniem przeczytać instrukcje

PT • ATENÇÃO. Leia as instruções antes da utilização e montagem

SK • UPOZORNENIE. Pred použitím a montážou si prečítajte pokyny

SL • OPOZORILO. Pred uporabo in montažo preberite navodila

FI • VAROITUS. Lue ohjeet ennen käyttöä ja kokoamista

SV • WARNING. Läs anvisningarna före användning och montering

RU • ВНИМАНИЕ. Перед эксплуатацией и сборкой внимательно прочитайте все инструкции

RO • AVERTISMENT. Citiți instrucțiunile înainte de utilizare și asamblare

 **ATTENZIONE!**

(IT) Leggere prima la **Parte Generale** e poi questo **Manuale Specifico**.

 **WARNING!**

(EN) First of all read the **General Section** and then this **Specific Manual**.

 **ATTENTION !**

(FR) Lire d'abord la **Partie Générale** puis ce **Manuel Spécifique**.

 **¡ATENCIÓN!**

(ES) Leer primero la **Parte General** y luego este **Manual Específico**.

 **UPOZORNĚNÍ!**

(CS) Nejdříve si přečtěte **Všeobecnou část** a poté tento **specifický návod**.

 **ACHTUNG!**

(DE) Zuerst **den allgemeinen** Teil und dann dieses **spezifische Handbuch** lesen.

 **ΠΡΟΣΟΧΗ!**

(EL) Διαβάστε προκαταρκτικά το **Γενικό Μέρος** και στην συνέχεια το **Ειδικό Εγχειρίδιο**.

 **FIGYELEM!**

(HU) Először az **Általános bevezető** fejezetet, utána pedig a jelen **Részletes műszaki útmutatót** olvassa el.

 **OPGELET!**

(NL) Lees eerst het **Algemene deel** en vervolgens deze **Specifieke handleiding** door.

 **UWAGA!**

(PL) Przeczytać najpierw **Ogólną Część** i następnie **Specjalny Podręcznik**.

 **ATENÇÃO!**

(PT) Leia antes a **Parte Geral** e a seguir este **Manual Específico**.

 **UPOZORNENIE!**

(SK) Najskôr si prečítajte **Všeobecnú časť** a potom tento **Špecifický návod**.

 **OPOZORILO!**

(SL) Preberite najprej **Odstavek Splošno** in potem to **Specifično knjižico**.

 **VAROITUS!**

(FI) Lue ensin **Yleinen osio** ja sitten tämä **Erityinen ohje**.

 **VARNING!**

(SV) Börja med att läsa det **Allmänna avsnittet** och sedan den här **broschyren**.

 **ВНИМАНИЕ!**

(RU) Сначала необходимо прочитать **Общую часть**, и затем данное **конкретное руководство**.

 **AVERTISMENT!**

(RO) Citiți mai întâi **Secțiunea Generală** și apoi această **Broșură Specifică**.

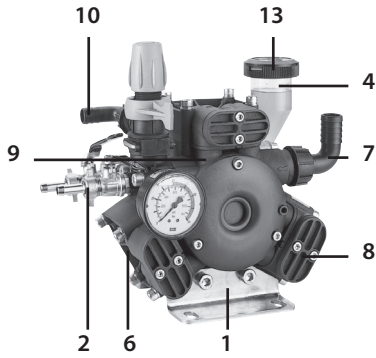

APS 31 - APS 41

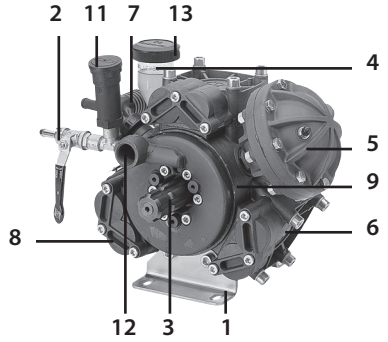

APS 51 - APS 61 - APS 71

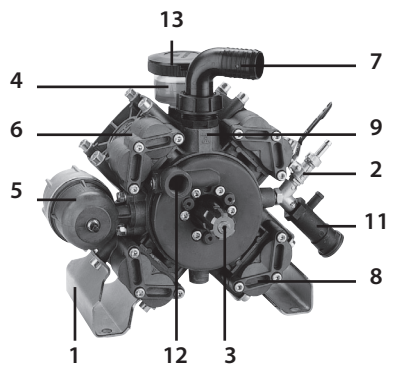

APS 96

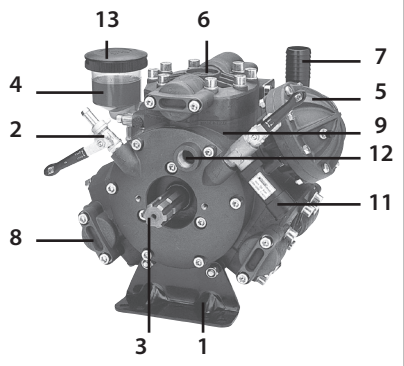

APS 101 - APS 121

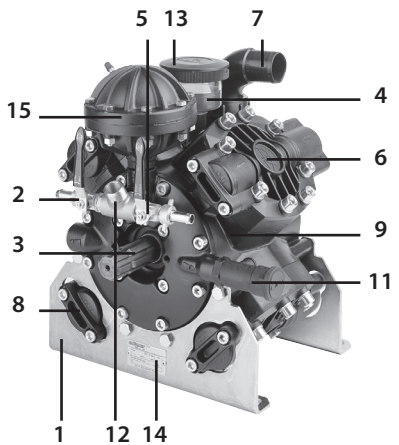



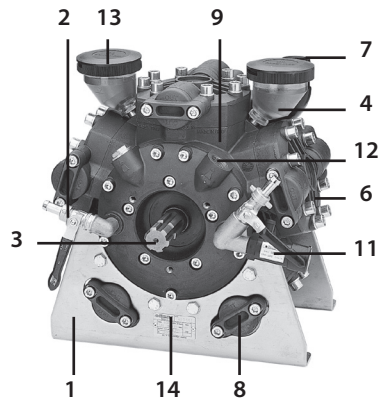













APS 145

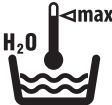

APS 141 - APS 166

1	(IT) Piede pompa ■ (EN) Pump support ■ (FR) Pied de pompe ■ (ES) Base de la bomba ■ (CS) Noha čerpadla ■ (DE) Pumpenfuß ■ (EL) Πόδι αντλίας ■ (HU) Szivattyú talapat ■ (NL) Pomponderstel ■ (PL) Nóżka pompy ■ (PT) Pé da bomba ■ (SK) Noha čerpadla ■ (SL) Podstavek črpalke ■ (FI) Pumpun jalka ■ (SV) Pumpfot ■ (RU) Основа насоса ■ (RO) Piciorul pompei
2	(IT) Rubinetto ■ (EN) Tap ■ (FR) Robinet ■ (ES) Grifo ■ (CS) Ventil ■ (DE) Wasserhahn ■ (EL) Στρόφιγγα ■ (HU) Csap ■ (NL) Kraan ■ (PL) Kurek ■ (PT) Torneira ■ (SK) Ventil ■ (SL) Pipa ■ (FI) Hana ■ (SV) Kran ■ (RU) Кран ■ (RO) Robinet
3	(IT) Albero pompa ■ (EN) Pump shaft ■ (FR) Arbre de pompe ■ (ES) Árbol bomba ■ (CS) Hřídel čerpadla ■ (DE) Pumpenwelle ■ (EL) Άξονας αντλίας ■ (HU) Szivattyú dugattyúja ■ (NL) Pompas ■ (PL) Wał pompy ■ (PT) Eixo da bomba ■ (SK) Hriadel čerpadla ■ (SL) Valj črpalke ■ (FI) Pumpun akseli ■ (SV) Pumpaxel ■ (RU) Вал насоса ■ (RO) Arbore de pompă
4	(IT) Compensatore volumetrico olio ■ (EN) Volumetric oil compensator ■ (FR) Compensateur volumétrique d'huile ■ (ES) Compensador volumétrico de aceite ■ (CS) Kompenzátor objemu oleje ■ (DE) Volumetrischer Kompensator des Öles ■ (EL) Ογκομετρικός αντισταθμιστής λαδιού ■ (HU) Olaj térfogat kompenzátor ■ (NL) Olievolume compensator ■ (PL) Kompensator volumetryczny oleju ■ (PT) Compensador volumétrico do óleo ■ (SK) Kompenzátor objemu oleja ■ (SL) Volumetrični kompenzator olja ■ (FI) Öljyn volumetrinen kompensattori ■ (SV) Volymetrisk kompensator för olja ■ (RU) Объемный компенсатор масла ■ (RO) Compensator volumetric ulei
5	(IT) Accumulatore di pressione ■ (EN) Pressure accumulator ■ (FR) Accumulateur de pression ■ (ES) Acumulador de presión ■ (CS) Tlakový akumulátor ■ (DE) Druckspeiche ■ (EL) Συσσωρευτής πίεσης ■ (HU) Nyomás szabályzó tartály ■ (NL) Drukaccumulator ■ (PL) Akumulator ciśnienia ■ (PT) Acumulador de pressão ■ (SK) Tlakový akumulátor ■ (SL) Akumulator za pritisk ■ (FI) Paineakku ■ (SV) Tryckackumulator ■ (RU) Аккумулятор давления ■ (RO) Acumulator presiune
6	(IT) Testata pompa ■ (EN) Pump head ■ (FR) Tête de pompe ■ (ES) Cabezal bomba ■ (CS) Hlava čerpadla ■ (DE) Pumpenkopf ■ (EL) Κεφαλή αντλίας ■ (HU) Szivattyú fejrész ■ (NL) Pompkop ■ (PL) Głowica pompy ■ (PT) Cabeça da bomba ■ (SK) Hlavica čerpadla ■ (SL) Glava črpalke ■ (FI) Pumpurpäähänne ■ (SV) Pump huvud ■ (RU) Головка насоса ■ (RO) Capul pompei
7	(IT) Raccordo di aspirazione ■ (EN) Intake coupling ■ (FR) Raccord de aspiration ■ (ES) Racor de aspiración ■ (CS) Sací spoj ■ (DE) Ansauganschluss ■ (EL) Συνδετικό αναρρόφησης ■ (HU) Bemeneti csatlakoztató ■ (NL) Inlaataansluiting ■ (PL) łącznik ssania ■ (PT) Junção de aspiração ■ (SK) Sací spoj ■ (SL) Montaža dovodne odprtine ■ (FI) Imuventtiilin sovitin ■ (SV) Insugstillbehör ■ (RU) Соединение всасывания ■ (RO) Fiting de intrare
8	(IT) Tappo valvola aspirazione/mandata ■ (EN) Intake/delivery valve cap ■ (FR) Bouchon clapet aspiration/refoulement ■ (ES) Tapón válvula de aspiración/envío ■ (CS) Zátka sacího/výtlačného ventilu ■ (DE) Stopfen Ansaug-/Auslassventil ■ (EL) Τάπα βαλβίδα αναρρόφησης/κατάθλιψης ■ (HU) Szívó/nyomó szelep kapcsoló ■ (NL) Dop in-/uitlaatklep ■ (PL) Korek zaworu ssącego/tłocznego ■ (PT) Tampa da válvula aspiração/envio ■ (SK) Zátka sacího/výtlačného ventilu ■ (SL) Dovodni/odtočni vtičak za ventil ■ (FI) Imu-/tulventtiilin tulppa ■ (SV) Insug/kontakt till matarventil ■ (RU) Пробка всасывающего нагнетательного клапана ■ (RO) Dop supară intrare/golire
9	(IT) Carter pompa ■ (EN) Pump crankcase ■ (FR) Carter de pompe ■ (ES) Cáster bomba ■ (CS) Kryt čerpadla ■ (DE) Pumpengehäuse ■ (EL) Κάρτερ αντλίας ■ (HU) Szivattyú külső burkolólemez ■ (NL) Pomphuis ■ (PL) Obudowa pompy ■ (PT) Cáster da bomba ■ (SK) Kryt čerpadla ■ (SL) Okvir črpalke ■ (FI) Pumpun pesä ■ (SV) Pumphus ■ (RU) Картер насоса ■ (RO) Carcasa pompei
10	(IT) Raccordo di by-pass ■ (EN) Bypass coupling ■ (FR) Raccord de by-pass ■ (ES) Racor de by-pass ■ (CS) Odbočný spoj ■ (DE) Bypass-Anschluss ■ (EL) Συνδετικό παράκαμψης ■ (HU) Elkerülő szakasz csatlakoztatója ■ (NL) Bypassaansluiting ■ (PL) Złączka by-pass ■ (PT) Junção de by-pass ■ (SK) Odbočný spoj ■ (SL) Montaža spodbujevalnika ■ (FI) Ohitusventtiilin sovitin ■ (SV) Förbikopplingsinstallation ■ (RU) Соединение байпаса ■ (RO) Fiting derivație
11	(IT) Valvola di sicurezza ■ (EN) Safety valve ■ (FR) Soupape de sûreté ■ (ES) Válvula de seguridad ■ (CS) Pojstný ventil ■ (DE) Sicherheitsventil ■ (EL) Βαλβίδα ασφαλείας ■ (HU) Biztonsági szelep ■ (NL) Veiligheidsklep ■ (PL) Zawór bezpieczeństwa ■ (PT) Válvula de segurança ■ (SK) Pojstný ventil ■ (SL) Varnostni ventil ■ (FI) Varoventtiili ■ (SV) Säkerhetsventil ■ (RU) Предохранительный клапан ■ (RO) Supară de siguranță
12	(IT) Raccordo di mandata ■ (EN) Delivery coupling ■ (FR) Raccord de refoulement ■ (ES) Racor de envío ■ (CS) Výtlačný spoj ■ (DE) Auslassanschluss ■ (EL) Συνδετικό κατάθλιψης ■ (HU) Kimeneti csatlakoztató ■ (NL) Uitlaataansluiting ■ (PL) łącznik po stronie tłocznej ■ (PT) Junção de envio ■ (SK) Výtlačný spoj ■ (SL) Montaža odtoka ■ (FI) Tulventtiilin sovitin ■ (SV) Matningsanordning ■ (RU) Нагнетательное соединение ■ (RO) Fiting golire
13	(IT) Tappo carico olio ■ (EN) Oil filler cap ■ (FR) Bouchon de remplissage d'huile ■ (ES) Tapón de carga aceite ■ (CS) Zátka pro doplňování oleje ■ (DE) Öfüllstopfen ■ (EL) Τάπα φόρτωσης λαδιού ■ (HU) Olaj utántöltő dugója ■ (NL) Olievuldop ■ (PL) Korek wlewowy oleju ■ (PT) Tampa de carga do óleo ■ (SK) Zátka nalievania oleja ■ (SL) Pokrov za oljni filter ■ (FI) Öljyntäyttöaukon korkki ■ (SV) Oljepåfyllningslock ■ (RU) Наливная пробка для масла ■ (RO) Dop umplere ulei
14	(IT) Targhetta di identificazione ■ (EN) Identification plate ■ (FR) Plaque d'identification ■ (ES) Placa de identificación ■ (CS) Identifikační štítek ■ (DE) Identifizierungsschild ■ (EL) Πλακέτα αναγνώρισης ■ (HU) Azonosító fémlapocsk ■ (NL) Typeplaatje ■ (PL) Tabliczka znamionowa ■ (PT) Placa de identificação ■ (SK) Identifikačný štítek ■ (SL) Identifikacijska plošča ■ (FI) Tunnistekilpi ■ (SV) Typskylt ■ (RU) Опознавательная табличка ■ (RO) Plăcuță cu date de identificare





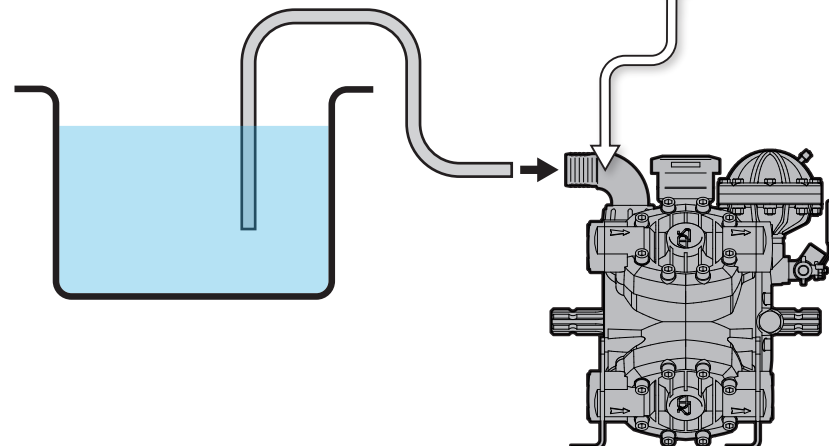
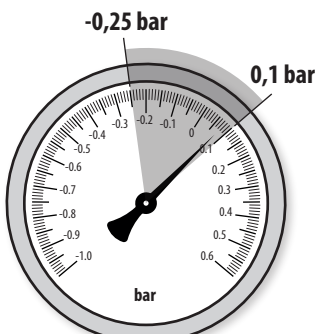
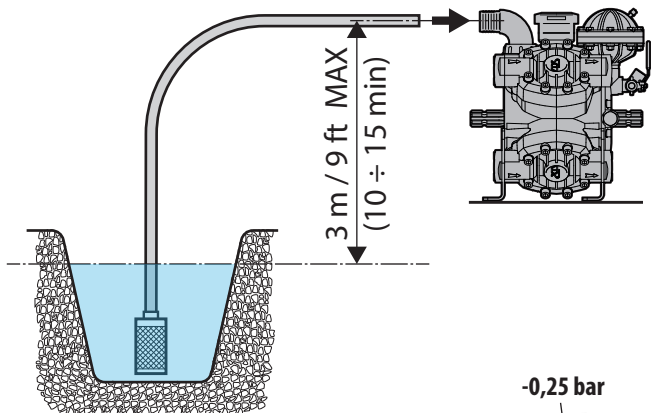

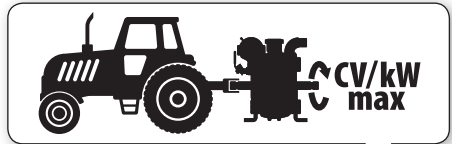



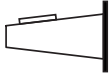

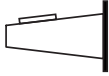

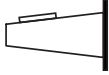
		APS 31	APS 41	APS 51	APS 61	APS 71	APS 96
kW/CV	[kW]	2,0	3,0	3,8	4,7	6,7	8,6
	[CV]	2,7	4,1	5,2	6,4	9,1	11,7
 rpm	[RPM] max.	550					
	[RPM] min.	400					
 OIL		AGIP SAE 20W/40					
 H ₂ O	[°C]	40					
	[°F]	104					
 H ₂ O	[°C]	5					
	[°F]	41					
 max bar	[l/min]	25,0	38,0	50,7	62,3	67,2	88,0
	[US gpm]	6,6	10,0	13,4	16,5	17,8	23,2
 0 bar	[l/min]	28,0	41,0	53,9	65,9	71,3	94,0
	[US gpm]	7,4	10,8	14,2	17,4	18,8	24,8
 max	[bar]	40				50	
	[psi]	580				725	
	[dB(A)]	< 70					
	[kg]	10,0		16,4	18,4		22,5
	[lb]	22,0		36,2	40,6		49,6

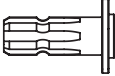
		APS 101	APS 121	APS 145	APS 141	APS 166
kW/CV	[kW]	9,1	10,7	13,2	13,1	15,1
	[CV]	12,3	14,5	18,0	17,8	20,5
 rpm	[RPM] max.	550				
	[RPM] min.	400				
 OIL		AGIP SAE 20W/40				
 H₂O	[°C]	40				
	[°F]	104				
 H₂O	[°C]	5				
	[°F]	41				
 max bar	[l/min]	94,0	115,0	142,0	141,0	163,0
	[US gpm]	24,8	30,4	37,5	37,2	43,1
 0 bar	[l/min]	100,0	120,0	149,0	145,0	169,0
	[US gpm]	26,4	31,7	39,2	38,3	44,6
 max	[bar]	50				
	[psi]	725				
	[dB(A)]	< 70				
	[kg]	38,0	46,0	56,0		
	[lb]	83,8	101,0	124,0		

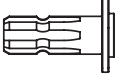

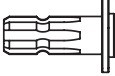

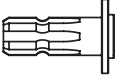
(IT) Tipo albero passante ■ (EN) Through-shaft type ■ (FR) Type d'arbre passant ■
 (ES) Tipo de cigüeñal pasante ■ (CS) Typ průchozí hřídele ■ (DE) Typ durchgehende Welle ■
 (EL) Τύπος περατού άξονα ■ (HU) Üreges szivattyú ■ (NL) Type doorvoerende as ■
 (PL) Typ walu przelotowego ■ (PT) Tipo de eixo passante ■ (SK) Typ prechodného hriadeľa ■
 (SL) S pomočjo vrste valja ■ (FI) Kulkuakselin tyyppi ■ (SV) Genomgående axeltyp ■
 (RU) Тип сквозного вала ■ (RO) Prin tipul arborelui

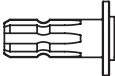
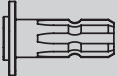
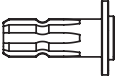
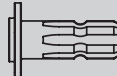
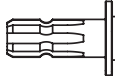
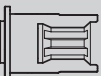
				CV	[kW]
APS 41		Ø20	 3xM8	6	[4,4]
		Ø20	 3xM10	9	[6,6]
		Ø20	 3xM8 3xM10	15	[11,0]
APS 51 APS 61 APS 71 APS 96		1" 3/8 M	 3xM8	6	[4,4]
		1" 3/8 M	 3xM10	9	[6,6]
		1" 3/8 M	 3xM8 3xM10	15	[11,0]
		1" 3/8 M	 1" 3/8 F	22	[16]
APS 71		1" 3/8 M	 1" 3/8 M	30	[22]
APS 96 APS 101 APS 121 APS 145 APS 141 APS 166		1" 3/8 M	 1" 3/8 M	45	[33]
APS 101 APS 121 APS 145		1" 3/8 M	 1" 3/8 F	22	[16]



COMET S.p.A. - Via G. Dorso, 4 - 42124 Reggio Emilia - ITALY

Tel. +39 0522 386111

E-Mail Italia: vendite@comet.re.it - fax +39 0522 386300

E-Mail Export: export@comet.re.it - fax +39 0522 386286

www.comet-spa.com

1610 1702 00 - 07/2015 - REV. 00